



# Getting to Know Your 2004 Silverado



Congratulations on your purchase of a Chevrolet Silverado. Please read this information and your Owner Manual to ensure an outstanding ownership experience. Note that your vehicle may not include all the features described in this booklet. Place this booklet in your Owner Manual portfolio for easy reference.

## Table of Contents

### INSIDE YOUR VEHICLE

- Instrument Panel ..... 2
- Instrument Panel Cluster ..... 3
- Heated Front Seats ..... 4
- Power Lumbar Front Seats ..... 4
- Passenger Automatic Locking Restraint (ALR) . 4
- Driver and Front Passenger  
Safety Belt Reminder ..... 4
- Automatic Dimming Rearview Mirror with  
OnStar®, Compass and Temperature Display . . 5
- Automatic Climate Control System ..... 5
- Manual Climate Control System ..... 6
- Entertainment Systems — Radio/CD ..... 6
- Steering Wheel Controls (OnStar®/Radio) . . . . 8

### OUTSIDE YOUR VEHICLE

- Power Folding Mirrors ..... 8
- Power Camper-Type Mirrors ..... 8
- Automatic Headlamp Controls ..... 9
- Daytime Running Lamps (DRL) ..... 9
- Content Theft-Deterrent System ..... 10
- PERSONALIZING YOUR VEHICLE
- Memory Positions for Driver's Seat, Mirrors,  
Pedals, Radio and Climate Controls ..... 10
- Memory Settings for Your Vehicle  
(Driver Information Center) ..... 11
- Odometer/Trip Settings ..... 13
- VEHICLE SYMBOLS GLOSSARY ..... 14
- ROADSIDE ASSISTANCE PROGRAM, My GMLink . . 16

**Instrument Panel**

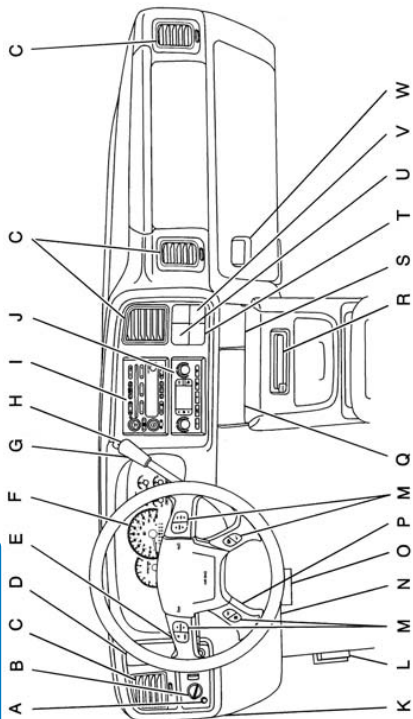

- A. Dome Lamp Button
- B. Exterior Lamp Controls
- C. Air Outlets
- D. Automatic Transfer Case/  
Electronic Transfer Case/  
Traction Assist System (TAS)
- E. Multifunction Lever
- F. Instrument Panel Cluster
- G. Gearshift Lever  
(automatic transmission)
- H. Tow/Haul Selector and Overdrive  
Disable Button (Allison  
Transmission only) (if equipped)
- I. Audio System
- J. Comfort Control System
- K. Instrument Panel Fuse Block
- L. Hood Release
- M. Steering Wheel Control Buttons  
(if equipped)
- N. Center Instrument Panel Utility Block
- O. Parking Brake Release
- P. Tilt Wheel Lever
- Q. Lighter and Accessory Power Outlet
- R. Storage Area or Cassette Tape  
Player (if equipped)
- S. Ashtray
- T. Manual Selectable Ride Control  
(if equipped)
- U. 4-Wheel Steering (4WS) Switch  
(if equipped)
- V. Passenger Air Bag Off Switch
- W. Glove Box

See Section 3 of your *Owner Manual*.

## Instrument Panel Cluster

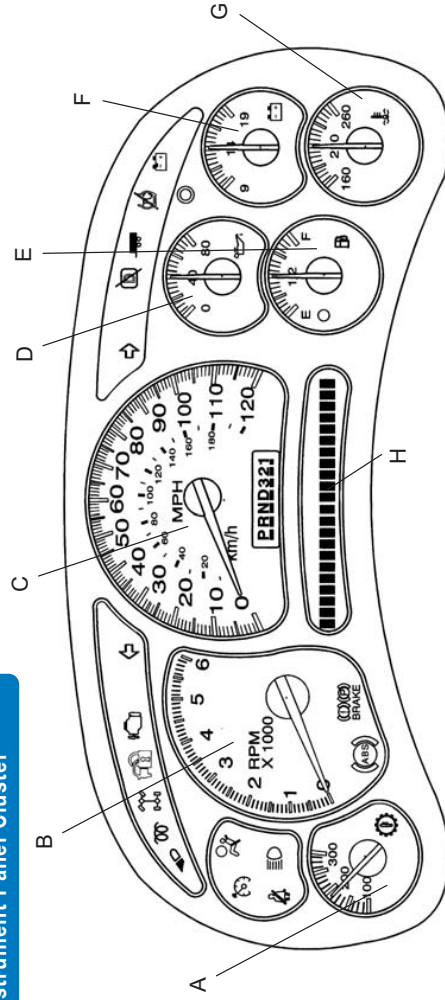

Your vehicle's instrument panel is equipped with this cluster or one very similar to it. The U.S. Heavy-Duty Automatic Transmission version is shown here.

The instrument panel cluster includes these key features:

- A. Transmission Temperature Gauge (if equipped)

- B. Tachometer

- C. Speedometer, Odometer, Transmission Gear Selector

- D. Oil Pressure Gauge

- E. Fuel Gauge

- F. Voltmeter

- G. Engine Coolant Temperature Gauge

- H. Driver Information Center (DIC)

See Section 3 of your Owner Manual.

**IMPORTANT:** See Section 3 of your Owner Manual for more information about what the lights, gauges and indicators on your vehicle's instrument panel tell you about your vehicle's operation.

**Heated Front Seats (if equipped)**

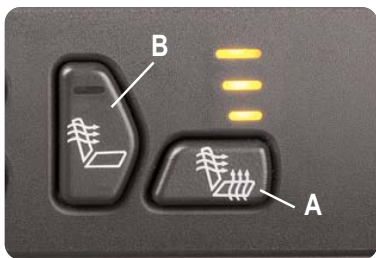

This feature allows you to heat the front seatbacks and seat cushions simultaneously or just the seatbacks. The controls are located on the driver and front passenger door panels.

**Select a heat setting for both the seatback and seat cushion**

- Press and release the horizontal button ("A" above) until the indicator light shows the desired setting.

**Select a heat setting for the seatback only**

- Press and release the vertical button ("B" above) until the indicator light shows the desired setting.

See Section 1 of your Owner Manual.

**Power Lumbar Front Seats (if equipped)**

**Adjust lumbar support**

- Press the front or rear of the control located on the side of the seat cushion near the door. Release at the preferred setting.



**Adjust outer portion of lumbar seat-back area**

- Press the top or bottom of the lumbar control. Release at the preferred setting.

**Passenger Automatic Locking Restraint (ALR)**

The safety belt is designed to lock during an accident, but it will also lock if it is pulled out all the way during initial buckling, and you may be unaware that this has happened. If the safety belt does lock, unbuckle it and allow it to retract fully, then pull it out and re-buckle the belt.

See Section 1 of your Owner Manual.

**Driver and Front Passenger Safety Belt Reminder (if equipped)**

If the ignition key is turned to RUN or START and the driver and/or front outboard passenger seatbelt is not buckled within five seconds, a chime will sound and the message "Buckle Seatbelt" (if the driver or driver and passenger are not buckled) or "Buckle Passenger" (if the passenger only is not buckled) will flash in the Driver Information Center.

The safety belt light (⚠) will also appear for several seconds and flash for several more seconds. If at any time while the vehicle is running the front-seat belts are not buckled, the message(s) and chimes will repeat.

**Note:** The safety belt reminder chime cannot be deactivated.

See Section 3 of your Owner Manual.

### Automatic Dimming Rearview Mirror with OnStar®, Compass and Temperature Display (if equipped)



Controls for the dimming feature, as well as OnStar® (if equipped) and the compass and temperature displays, are located on the bottom of the mirror.

When on, the automatic interior dimming rearview mirror automatically dims to the proper level to minimize glare from lights behind you when it's dark outside.

#### Turn the self-dimming function on or off

- Press and hold  for approximately eight seconds.

#### Use the OnStar Communications system

- Press  to connect to an OnStar® Advisor.
- Press  to answer or end a call from the OnStar® Center.
- Press  in an emergency to connect to an OnStar® Advisor who can contact the nearest emergency services provider.

#### Turn the outside temperature displays and compass readings on or off

- Press .

#### Display temperature

- Press  and hold for four seconds (until the display blinks) to toggle between °C and °F. Once the desired °C or °F is displayed, release the button. Wait four seconds and the temperature will be displayed.

See Section 2 of your Owner Manual.

### Automatic Climate Control System (if equipped)



#### Adjust settings for automatic operation

- Push the AUTO button ("A" above) and adjust the temperature knob ("B" above) to the desired temperature.

When automatic operation is active, the system will control the inside temperature, air delivery, and fan speed.

#### Set same temperature for driver and front passenger

- Press and hold the AUTO button for four seconds.
- Press and hold the AUTO button again for four seconds to return to individual driver/front passenger controls.

#### Select air distribution manually

- Press and release the MODE button ("C" above) until the desired source of air is indicated on the display.

The MODE feature allows you to select air delivery to the floor, the instrument panel outlets, or the windshield outlets.

#### Manually raise or lower fan speed

- Press the upper or lower portion of the FAN control button ("D" above).

See Section 3 of your Owner Manual.

**Manual Climate Control System (if equipped)**



**Adjust settings for operation**

- Adjust air delivery location with mode control knob (“A” above).
- Adjust driver/passenger temperatures with levers (“B” above).
- Set fan speed to desired setting (“C” above).

**Additional Climate Control System Functions**

: Recirculates interior air while in Vent, Bi-Level positions. To prevent window fogging, Recirculation will not operate in the Defog, Defrost or Floor mode.

: Clears windshield and front side windows of fog/frost.

: Clears rear glass of fog/frost and activates heated outside rearview mirrors (if equipped).

: Turns the air conditioning system on and off. The button’s LED will illuminate when the air conditioning system is on.

**Note:** When the climate control system is in the OFF position (O), outside air will continue to enter the vehicle and will be directed according to the mode position selected. This is normal climate control operation.

See Section 3 of your Owner Manual.

**Entertainment Systems — Radio/CD**



**Set the time on radios *without* a Radio Data System (RDS)**

- Press and hold the HR or MIN arrow for two seconds.
- Press the HR (down) arrow until the correct hour appears on the display.
- Press and hold the MIN (up) arrow until the correct minute appears on the display.

**Set the time on radios *with* a Radio Data System (RDS)**

Your radio may have a button marked “H” or “HR” to represent hours and an “M” or “MIN” to represent minutes.

- Press and hold the hour button until the correct hour appears on the display.
- Press and hold the minute button until the correct minute appears on the display.

**Note:** The time may be set with the ignition on or off.

### Program radio station presets

- Turn the radio on.
- Press BAND to select the band (AM, FM1/FM2/XM1/XM2).
- Use the seek or tune knob to tune in the desired station.
- Press AUTO EQ or AUTO TONE (as applicable to your radio) to select the equalization that best suits the type of station selected.
- Press and hold one of the six numbered buttons until a beep sounds; release the button.
- Repeat these steps for each station preset, using a different numbered button for each station.

### Access one of the two available XM Satellite Radio bands (if equipped)

- Press the BAND button until XM1 or XM2 appears on the display. Note: Requires subscription to XM Radio.

### Six-Disc CD Changer (if equipped)

#### Load 1 CD

- With the ignition on, press and release the LOAD side of the LOAD CD button.
- Wait for the green indicator light at the right side of the slot to turn green.
- Insert the disc partway into the slot, label side up; the player will pull the disc in.

#### Load multiple CDs

- With the ignition on, press and hold the LOAD button for two seconds. The unit beeps and the light to the right of the slot begins to flash.



- When the light stops flashing and turns green, insert a disc partway, label side up.
- The indicator light will begin blinking and turn steadily green. Load another disc at this time.
- When loading more than one but fewer than six CDs, press the LOAD button again to signal that loading is complete.
- When more than one disc is loaded, a number for each disc is displayed.
- To play a specific CD, press the CD AUX button and then the number of the CD you want to hear.
- A small bar appears under the CD number that is playing, and the track number appears.

### Navigation Radio (if equipped)

See your Owner Manual or Navigation Radio Guide for operating instructions.

See *Section 3 of your Owner Manual.*



### Steering Wheel Controls (OnStar®/Radio) (if equipped)



**(OnStar/Voice Recognition)** (if equipped): This button will activate OnStar® for use. (Note: If your vehicle is not equipped with the OnStar® Communication System, pressing this button will mute the radio). For additional OnStar® features information, including Personal Calling and Virtual Advisor, see the OnStar® System section of your Owner Manual.)

**PROG:** This button will cycle through the radio presets.

◀SOURCE▶ : Selects AM, FM, XM Satellite Radio (if equipped), cassette or CD

◀SEEK▶ : Seeks radio stations

◀VOL▶ : Adjusts radio volume

See Section 3 of your Owner Manual.

### Power Folding Mirrors (if equipped)

#### Fold mirrors

- Move the selector switch located above the mirror control ("A" above) to the center position.
- Press the right side of the four-way control pad ("B" above) to fold the mirrors in.
- Press the left side of the four-way control pad to fold the mirrors out.



If the mirrors have been folded manually, they must be moved through the power folding cycle three times to reset them in their tracks.

See Section 2 of your Owner Manual.

### Power Camper-Type Mirrors (if equipped)

#### Extend or retract mirrors

- Move the selector switch located above the mirror control to the center position (as shown under Power Folding Mirrors above).
- Press the left side of the four-way control pad to extend mirrors.
- Press the right side of the four-way control pad to retract mirrors.

See Section 2 of your Owner Manual.



### Automatic Headlamp Controls



#### Turn off Daytime Running Lamps (DRL) and automatic headlamps

- Turn the exterior lamps knob (located to the left of the steering wheel) to OFF (O).

#### Activate the automatic headlamp system

- Turn the exterior lamps knob to AUTO. The automatic headlamp system will turn on the front and rear lamps.

#### Illuminate the parking lamps, side-marker lamps, taillamps, instrument panel/radio lights, license plate lamps and roof marker lamps (if equipped)

- Turn the exterior lamps knob to the parking lamp position (☞☜).

#### Manually activate the headlamps, all exterior tail/marker lamps and the instrument panel/radio lights

- Turn the exterior lamps knob to this position (☞☜).

#### Turn the fog lamps (if equipped) on or off

- Press the fog lamp button located on the left side of the instrument panel. An indicator lamp will illuminate when the fog lamps are on.



See Section 3 of your Owner Manual.

### Daytime Running Lamps (DRL)

#### Disable the DRL when Idling

- Shift the vehicle into PARK, or
- Set the parking brake.

**Note:** Your DRLs will re-engage at the next key cycle.

See Section 3 of your Owner Manual.

### Content Theft-Deterrent System (if equipped)

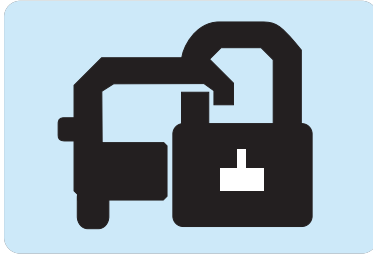

#### Arm the System

- Lock the doors using the power door lock switch or the Keyless Entry System transmitter. The alarm is activated when the symbol shown above illuminates in the instrument cluster (approximately 30 seconds).

If your vehicle is equipped with a Driver Information Center, you can program the alarm to the following:

- Both Horn/Headlamps
- Horn only
- Lamps only
- Off

**Note:** Your vehicle's factory default setting is Horn and Lamps. See the Personalizing Your Vehicle section of this booklet for more information.

See Section 2 of your Owner Manual.

### Memory Positions for Driver's Seat, Mirrors, Pedals, Radio and Climate Controls (if equipped)

Use the driver's door mounted controls to:

- Adjust driver seat, including lumbar adjustment
- Adjust gas and brake pedals
- Adjust the outside rearview mirrors
- Set the radio presets and climate control temperature (the climate control temperature setting will revert to the last temperature setting used)
- Press and hold Memory 1 or 2 until two chimes sound (about four seconds)
- To set up for another driver, repeat the process with the other memory button



These settings will be remembered after they are programmed by pressing the Memory 1 or 2 button on the driver's door (shown above).

If you unlock the vehicle with the Remote Keyless Entry (RKE) transmitter, the vehicle memory settings will correspond to the number on the RKE transmitter: 1 or 2.



See Section 2 of your Owner Manual.

### Memory Settings for Your Vehicle (Driver Information Center) (if equipped)

Your vehicle may be programmed with the features shown below. To cycle through them, use the Personalization/Menu button (☰) located on your steering wheel.

- Alarm Warning Type
- Automatic Locking/Unlocking
- Perimeter Lighting
- Delayed Locking
- Remote Lock/Unlock Feedback
- Seat Position Recall
- Headlamps On at Exit
- Easy Exit Driver Seat
- Display Units
- Display Language
- Curb View Assist (if equipped)

#### Selection Options

Use the Select button (←) to choose your desired setting. The last setting remaining on the display will be the selection of choice. Continue cycling through the menu with the Personalization/Menu button (☰) to set other preferences.

#### Alarm Warning Type

1. Alarm Warning: Both (default)
2. Alarm Warning: Off
3. Alarm Warning: Horn
4. Alarm Warning: Lamps

#### Automatic Door Locking/Unlocking Options

##### *Locking:*

1. Lock Doors Out of Park
2. Lock Doors Manually
3. Lock Doors with Speed (approx. 8 mph)

##### *Unlocking:*

1. Unlock All in Park
2. Unlock All at Key Out of Ignition
3. Unlock Manually
4. Unlock Driver Only in Park

#### Remote Lock/Unlock Options

1. Flash Lamps
2. Sound Horn
3. Both Lamps and Horn
4. Off

**Note:** The RKE transmitter LOCK/UNLOCK button must be pressed twice to receive horn feedback.

#### Perimeter Lighting Options

1. Perimeter Lighting On — Headlights and backup lights will come on for 40 seconds when unlocked with remote
2. Perimeter Lighting Off

#### Delayed Locking

1. On
2. Off

Seat Position Recall Options

1. Seat Position Recall Off — Memory Seat position will only be recalled when you press memory button 1 or 2 on the driver's door
2. Seat Position Recall at Key In
3. Seat Position Recall On Remote

Easy Exit Driver Seat

1. Adjust the seat to the desired position.
2. Press and hold the exit button () on the driver's door until two chimes sound. (Note: Seat Exit must be "On" in your programmed settings.)

Headlamp On at Exit

1. Headlamp Delay: 10 sec (default)
2. Headlamp Delay: 20 sec
3. Headlamp Delay: 40 sec
4. Headlamp Delay: 60 sec
5. Headlamp Delay: Off

Curb View Assist Option (requires Steering Wheel Controls)

1. Curb View Off
2. Curb View Passenger
3. Curb View Driver
4. Curb View Both

The Curb View Assist feature automatically tilts your outside mirrors downward to allow you to see curbs when backing up.

**Set Curb View Assist position**

- Enable one of the four selections above.
- Adjust the mirrors while the vehicle is in reverse. When the vehicle is shifted out of reverse, your selection is saved in Memory 1 or 2.

**Note:** Memory 1 or 2 is dependent on the RKE transmitter being used and the key being in the ignition during programming.

See *Section 2 of your Owner Manual*.

### Odometer/Trip Settings (if equipped)

Your vehicle's personal trip and business trip odometers operate only when they are turned on. The controls are located on the steering wheel.



#### Enable the system

- Press the Trip button (🚗) until the words "Personal Trip" appear. Then press ⬅️ to denote Personal Trip ON. Press the Trip button again to monitor your mileage. (Note: Continue to press the Trip button to monitor the features shown in the next column.)

Use the above procedure to monitor the following settings:

- Personal/Business: Miles
- Personal/Business: Gal.
- Personal/Business: Avg. MPG
- Personal/Business: MPH
- Personal/Business Annual % Usage
- Business: Hourmeter (Total Engine Run Time)
- Business: Annual Log
- Business: Timer

#### Reset trip information

- Press and hold the Select button (⬅️) for two seconds while viewing any of the trip modes on the Driver Information Center.

































**Note:** Whether your vehicle is equipped with a Driver Information Center or not, you can select and reset trip features by using the Trip Odometer Reset Stem located on the instrument panel cluster.

See *Section 2 of your Owner Manual*.

## Vehicle Symbols Glossary

rremove border

Following are examples of symbols you may find on your vehicle. It is important to become familiar with them, as they alert you to various vehicle operating conditions.

	Air Bag Readiness Light		Four-Wheel Steer (if equipped)
	Air Conditioning (A/C)		Headlamps
	Antilock Brake System Warning Light		Instrument Panel Brightness Control
	Auxiliary Roof-Mounted Lamp Switch (if equipped)		Malfunction Indicator Lamp (Check Engine Light)
	Battery Warning Light		Off (for example, headlamp and climate control)
	Brake System Warning Light		Off/On (for example, inside rearview mirror)
	Cargo Lamp Button		On (for example, cruise control lever)
	Content Theft Deterrent		Overdrive Disabled (Shown on shift lever, if equipped with Allison transmission)
	Cruise Control Set		Parking Lamps
	Dome Lamps Override Button		Driver and Front Passenger Safety Belt Reminder Light (if equipped)
	Driver Information Center Trip Information Button (on steering wheel)		Rear Door Security Locks (if equipped)
	Driver Information Center Fuel Information Button (on steering wheel)		Rear Window Defogger (if equipped)
	Driver Information Center Personalization/Menu Button (on steering wheel)		Tow/Haul Mode Light
	Driver Information Center Select Button (on steering wheel)		Traction Off Light
	Fog Lamps		Up-Shift Light (vehicles with manual transmission)
	Four-Wheel Drive Light		
	Front and Side Window Defrost		





**Roadside Assistance Program****1-800-CHEV-USA**

(1-800-243-8872)

TTY Users: 1-888-889-2438

As the owner of a 2004 Chevrolet, membership in the Roadside Assistance Program is free.

Roadside Assistance is available 24 hours a day, 365 days a year by calling one of the above numbers. An advisor will provide you with over-the-phone roadside assistance with minor mechanical problems. If the problem can't be resolved over the phone, our advisors have access to a nationwide network of dealer-recommended service providers. Roadside membership is free; however, some services may incur costs.

Roadside offers two levels of service: Basic Care and Courtesy Care.

**Roadside Basic Care provides:**

- Toll-free number (shown above)
- Free towing for warranty repairs
- Basic over-the-phone technical advice
- Available dealer services at reasonable costs (i.e., wrecker services, locksmith/key service, glass repair)

**Roadside Courtesy Care provides:**

- Roadside Basic Care services (as outlined previously)

Plus:

- FREE Non-Warranty Towing (to the closest dealer from a legal roadway)

- FREE Locksmith/Key Service (when keys are lost on the road or locked inside)
- FREE Flat Tire Service (spare installed on the road)
- FREE Jump Start (at home or on the road)
- FREE Fuel Delivery (\$5 of fuel delivered on the road)

Courtesy Care is available to retail and retail lease customers operating 2004 and newer Chevrolet vehicles for a period of 3 years/36,000 miles (60,000 km), whichever occurs first.

For prompt and efficient assistance when calling, please provide the following information to the advisor:

- Vehicle Identification Number (VIN)
- Vehicle license plate number
- Vehicle color and mileage
- Location of the vehicle
- Telephone number where you can be reached
- Description of problem

**My GMLink**

The Chevrolet Owner Center at MyGMLink is a complimentary service for Chevrolet Owners, a one-stop resource to enhance your Chevrolet ownership experience. Exclusive member benefits include online service reminders, vehicle maintenance tips, online owner manual, special privileges and more. Sign up today at [www.mygmlink.com](http://www.mygmlink.com)

Certain restrictions, precautions and safety procedures apply to your vehicle. Please read your Owner Manual for complete instructions. All information contained herein is based on information available at the time of printing and is subject to change without notice. Copyright 2003 by GM Corp. All rights reserved.



04SILVQRG

**CHEVROLET**